



300 x 140 x 40 mm



1,74 kg



Steel / HDG



EN 13374, class A

Description

The VT Edge 100 serves as a stair attachment for the securing of stair edges. The cantilever of the Vivatec edge protection post is 100 mm and therefore enables finishing work to be carried out on the staircase.

Attaching to all vertical surfaces is made possible by the two fixing points, which also allow an overlying attachment on the slab edge/stair edge.

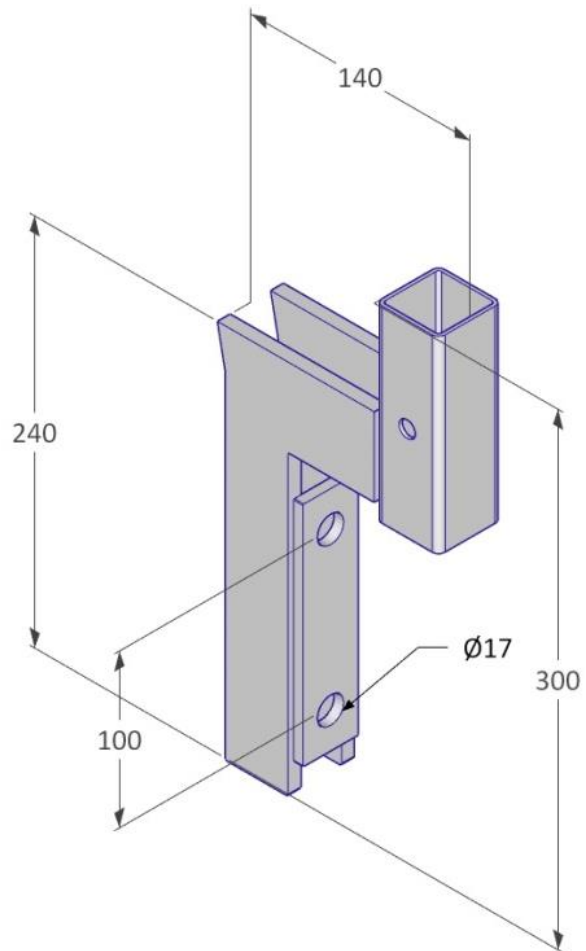

mm



250 pcs / Eurobox



1240 x 835 x 970 mm



505 kg

Means of Fixation

Tensile load of the screws min. 10 kN
 → Hilti HUS3-H10 L-130mm or the like / better, assembly torque limit min. 60 Nm

General Safety

Health and Safety Regulation should be followed at all times. For more information → viva-tec.com/safety



300 x 140 x 40 mm



1,74 kg



Steel / HDG



EN 13374, class A

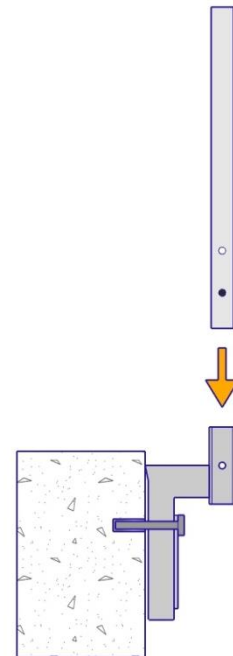
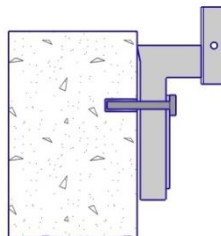
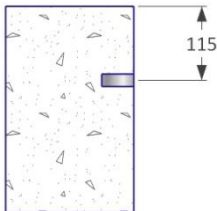
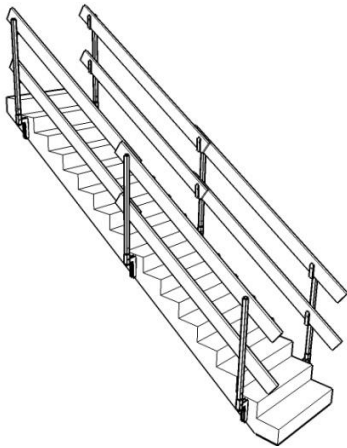
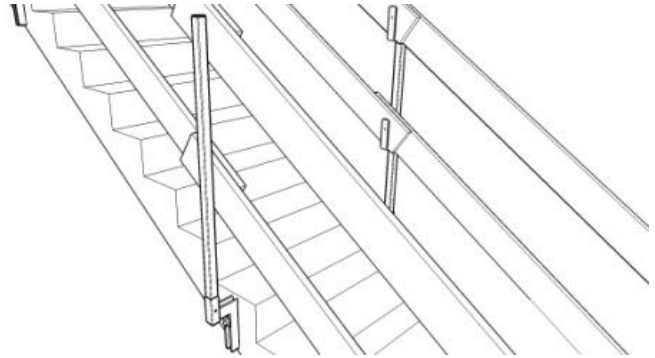

mm

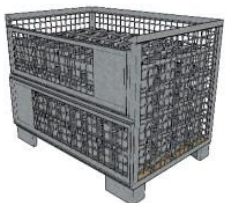

250 pcs / Eurobox



1240 x 835 x 970 mm



505 kg

Means of Fixation

Tensile load of the screws min. 10 kN
 → Hilti HUS3-H10 L-130mm or the like / better, assembly torque limit min. 60 Nm

General Safety

Health and Safety Regulation should be followed at all times. For more information → viva-tec.com/safety