



224 x 60 x 60 mm



0,64 kg



Steel / HDG

Description

The VT Adapter 40 fixes the post in the ground anchor for cementing into foundation – 40 mm round steel to 35 mm square steel.

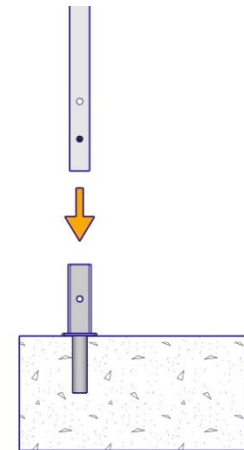
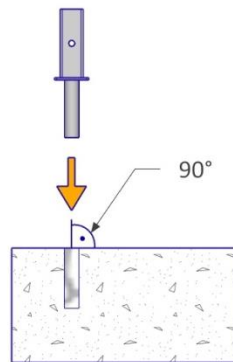
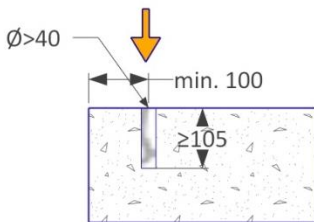
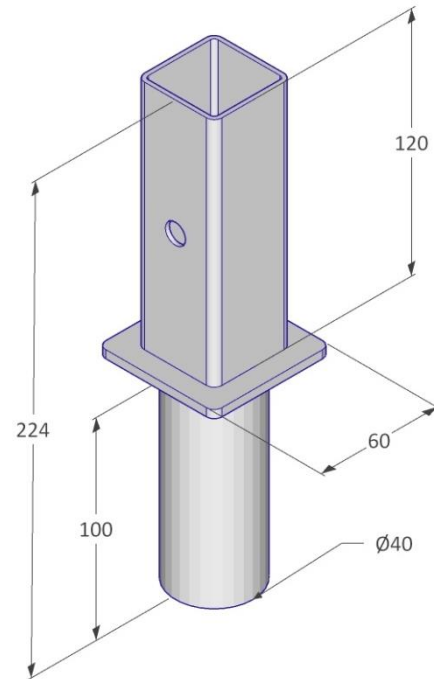

mm

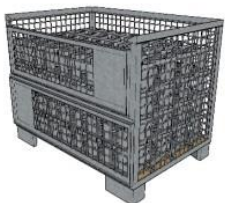

500 pcs / Eurobox



1240 x 835 x 970 mm



390 kg

General Safety

Health and Safety Regulation should be followed at all times. For more information → viva-tec.com/safety