



270 x 190 x 75 mm



2,0 kg



Steel / HDG

Description

The VT Joist Hanger 55 is used to hold a beam and thus forms a substructure for working platforms, for example in shafts.

With counter pressure from bars/wedges, the permissible load capacity is 10 kN, without counter pressure 6 kN.

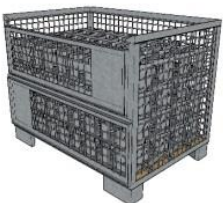
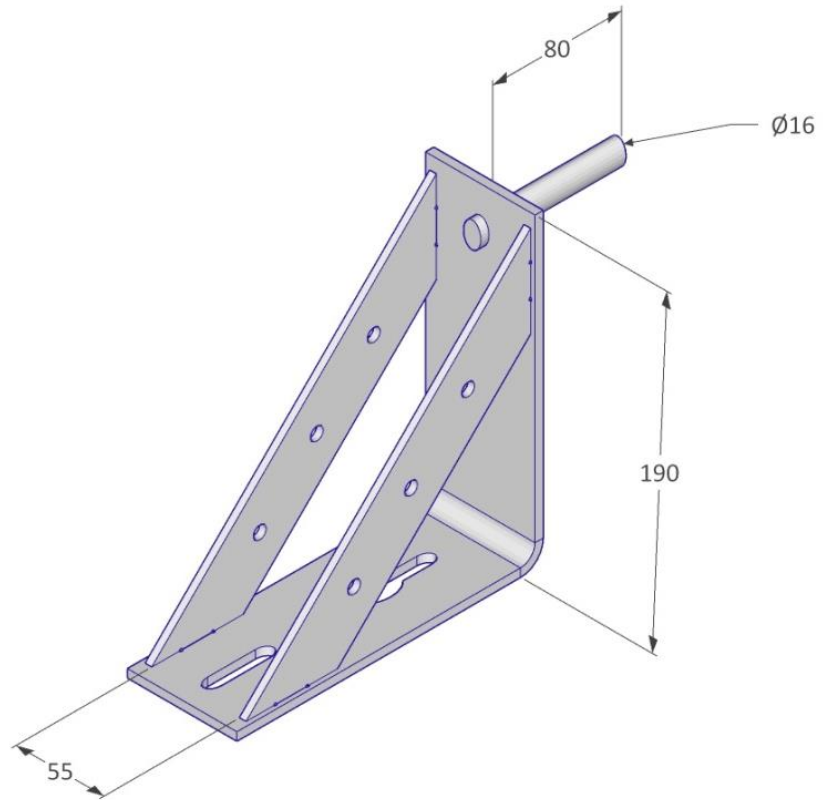

200 pcs / Eurobox



1240 x 835 x 970 mm



358 kg

Load impact

Care should be taken to distribute loads evenly on the joist hangers or platforms.

General Safety

Health and Safety Regulation should be followed at all times. For more information → viva-tec.com/safety