

 4000 mm

 87 kg

 Steel / HDG & Aluminium

 EN 1263-1

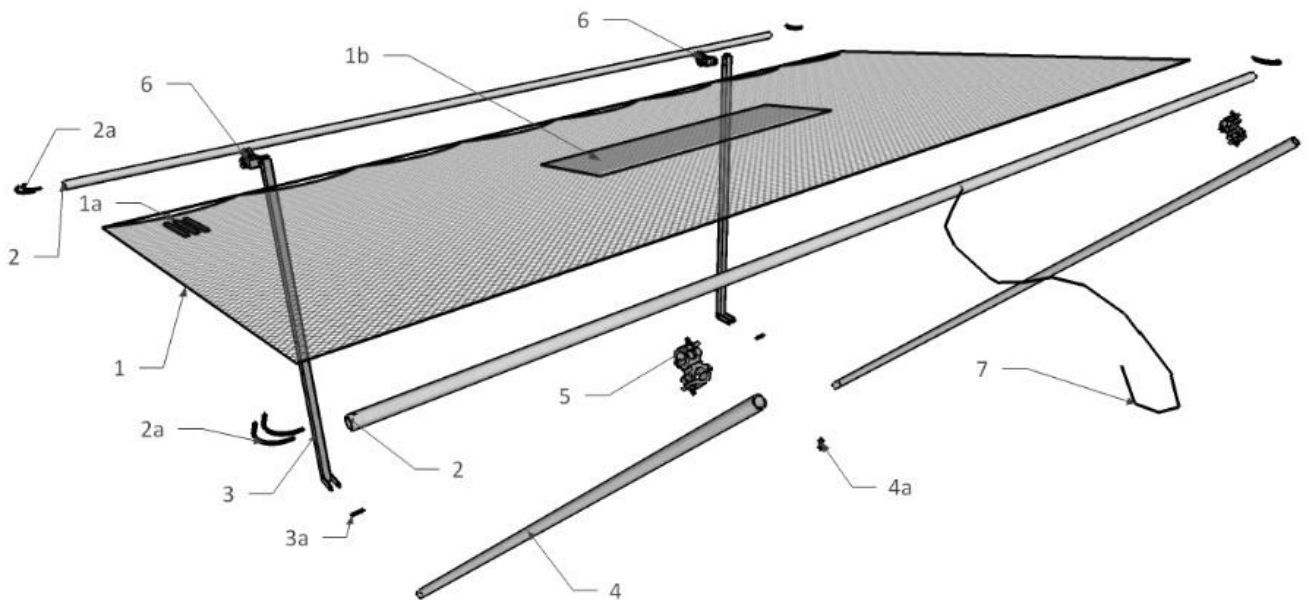
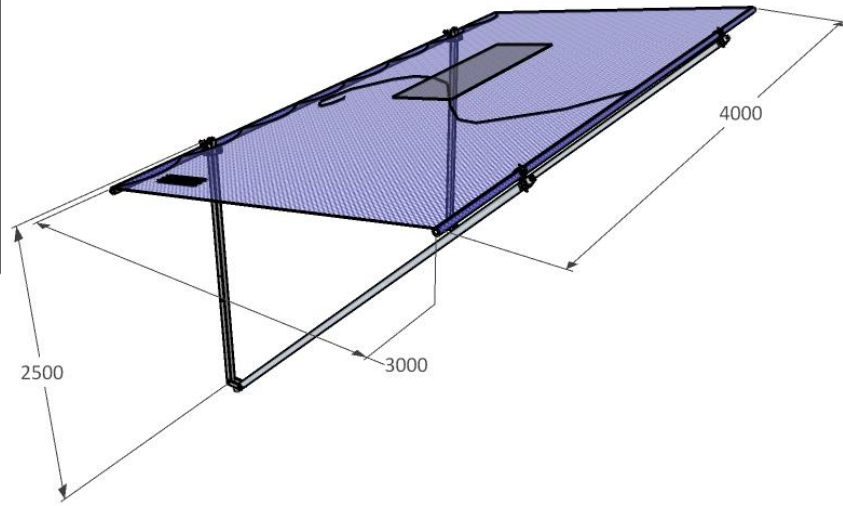

1/2



 10 pcs / Stillage box

 4000 x 800 x 900 mm

 950 kg

Tools:



 4000 mm

 87 kg

 Steel / HDG & Aluminium

 EN 1263-1

No.	Pcs.	Art. No.	Product	Weight (kg)
1	1	5050010	Safety Net (M60 & M20)	9,0
1a	3	-	Test cord EN 1263-1	-
1b	1	5050011	Banner	0,2
2	2	5056002	Aluminium Tube (4 m)	6,0
2a	8	-	Plastic strap	-
3	2	5056001	Body Tube (2,5 m)	11,4
3a	2	-	Bolt & Nut M12x80	0,1
4	2	5056003	Aluminium Tube (4,20 m)	6,3
4a	2	-	Bolt & Nut M6x12	0,05
5	2	5056005	Coupler round/round EN 74	1,34
6	2	5056004	Coupler round/square EN 74	1,56
7	1	5050012	5,0 m pull in Rope PP	0,15



 10 pcs / Stillage box

 4000 x 800 x 900 mm

 950 kg

Tools:

