



 2037 x 1037 x 1054 mm

 156 kg

 Steel / HDG

 EN 12811

 Max. load: 5kn/m²

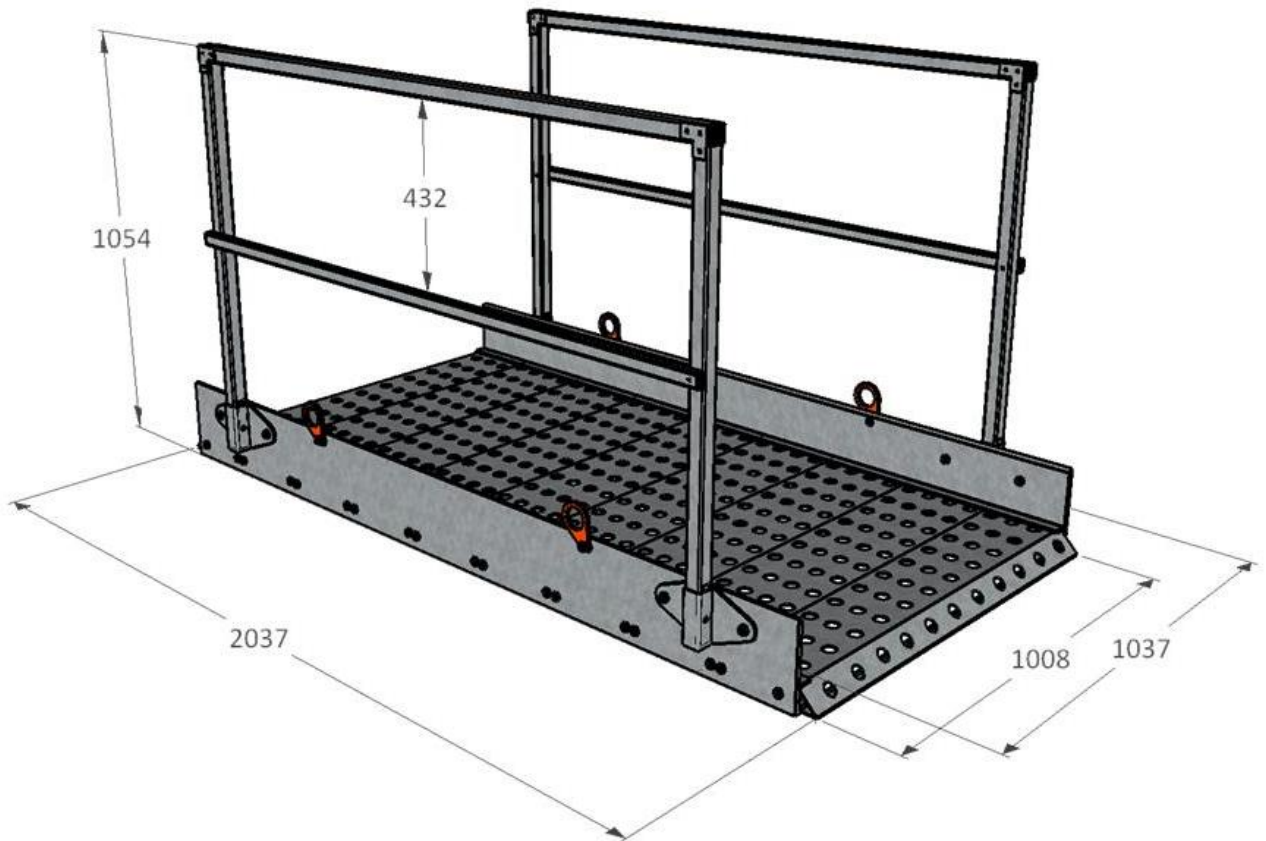

 10 pcs / EPAL

 2037 x 1037 x 1400 mm

 1580 kg