



 2935 x 1137 x 1054 mm

 236 kg

 Steel / HDG

 EN 12811

 Max. load: 5 kn/m²

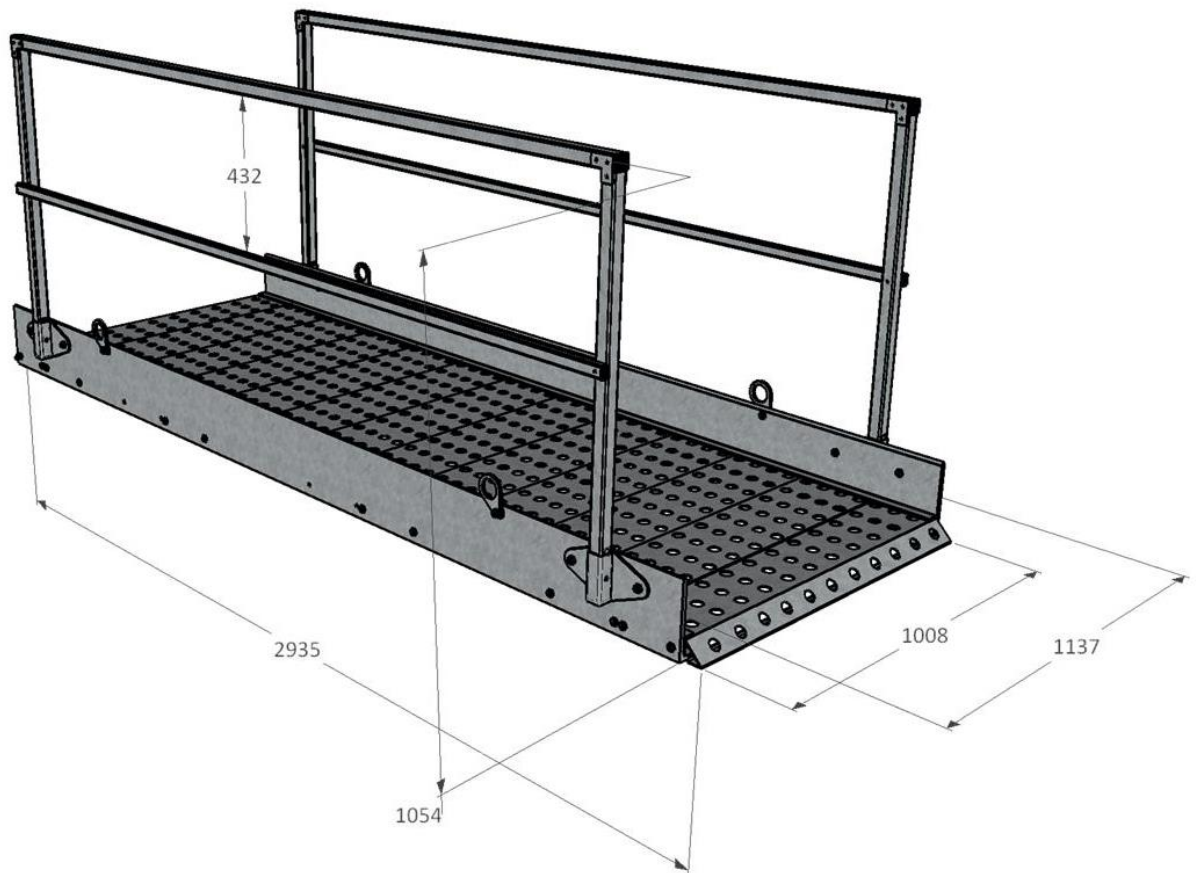

 5 pcs / EPAL

 2935 x 1137 x 775 mm

 1200 kg