 1640 x 1120 x 100 mm

 54 kg

 Steel / HDG

 EN 12811

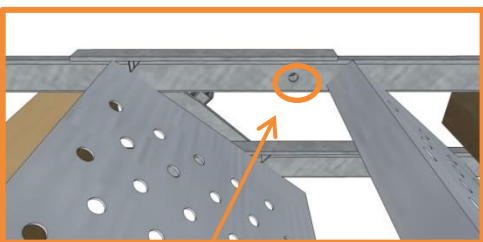

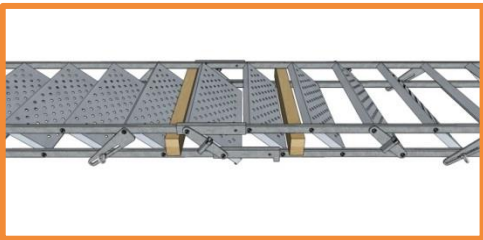
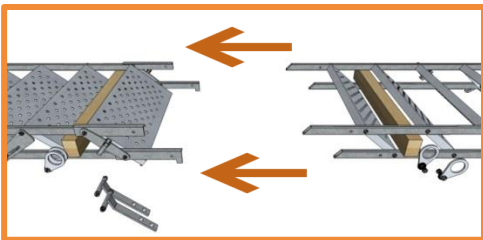
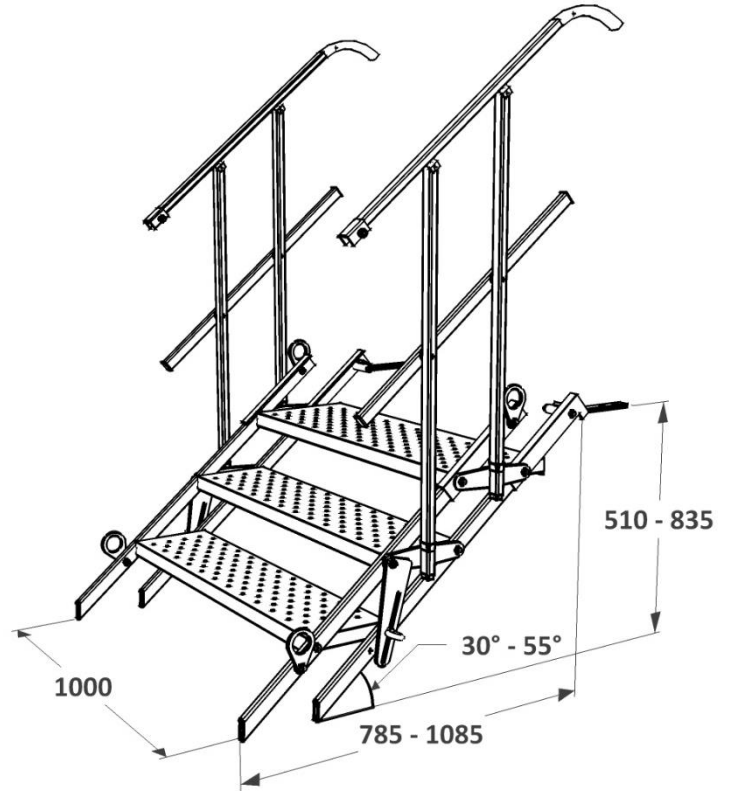

4x

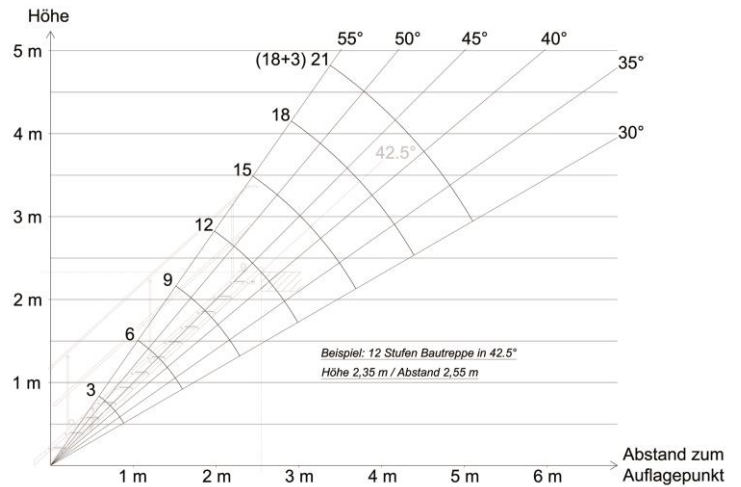
Inclination Diagram



 10 pcs / EPAL

 1640 x 112 x 1150 mm

 560 kg

Tools:

