

 1640 x 800 x 100 mm

 39 kg

 Steel / HDG

 EN 12811

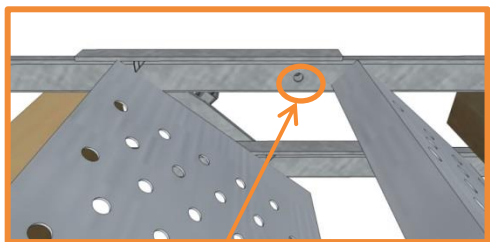
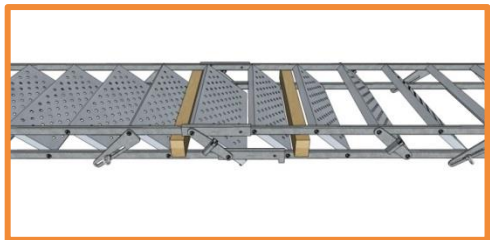
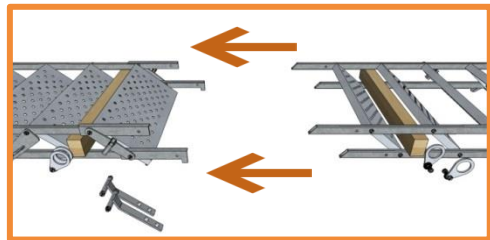
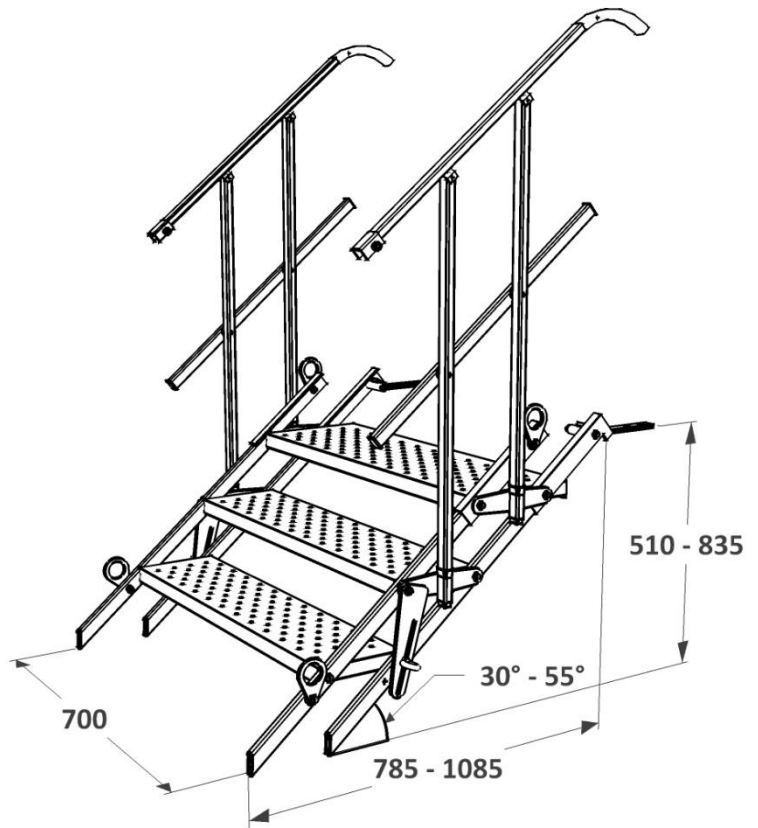

Inclination Diagram

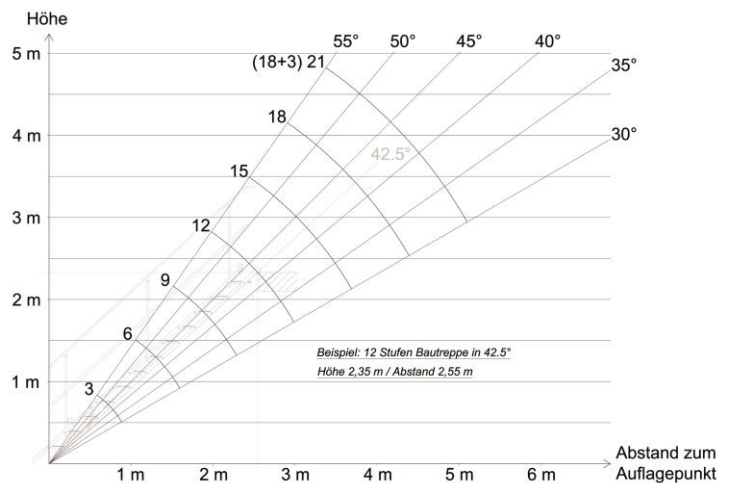

 10 pcs / Euro Pallet

 1640 x 800 x 1000 mm

 410 kg

Tools:

