

 1195 x 35 x 35 mm

 3,2 kg

 Steel / HDG

 EN 13374-A

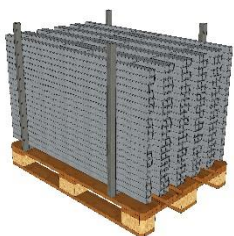
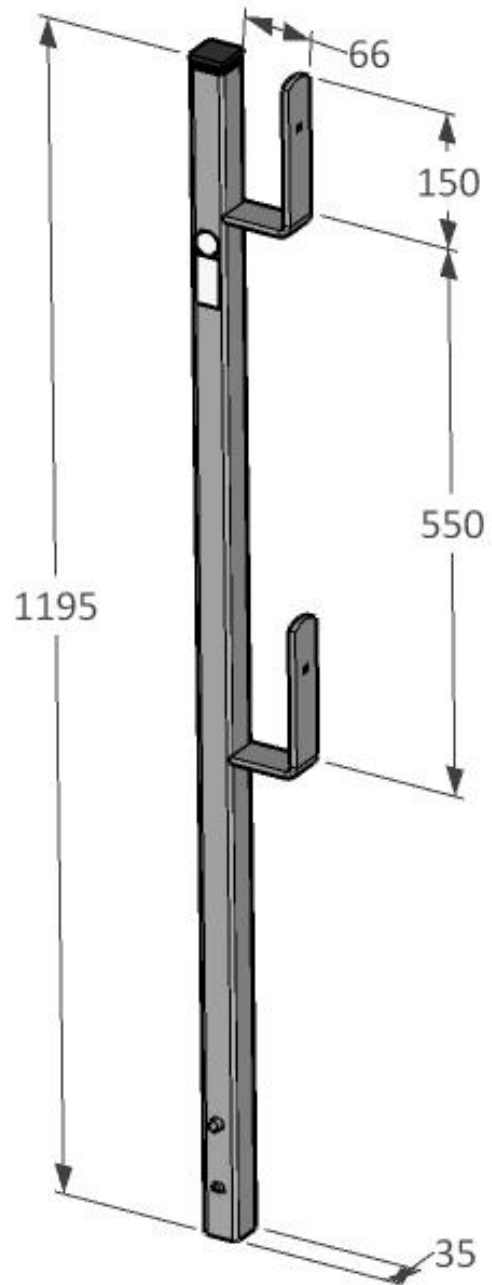
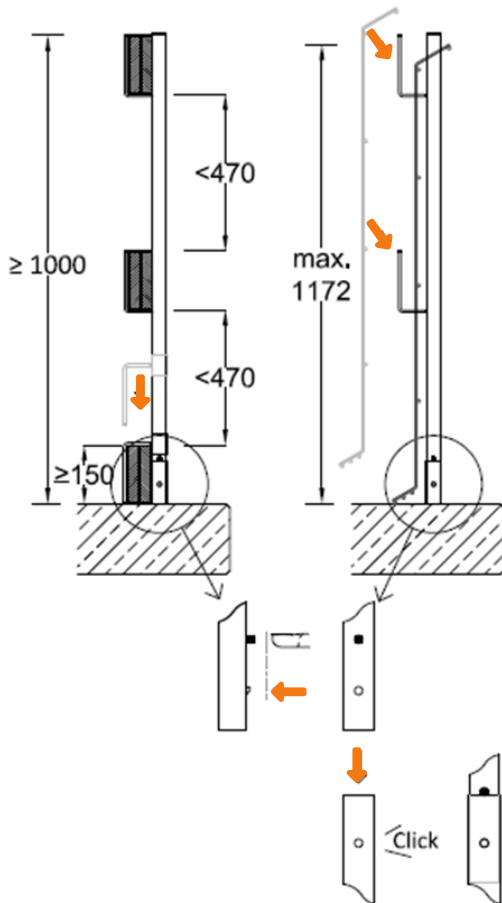

 100 pcs / EPAL

 1200 x 800 x 800 mm

 340 kg