



 1500 x 35 x 35 mm

 3,12 kg

 Steel / HDG

 EN 13374-A

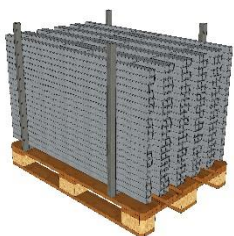
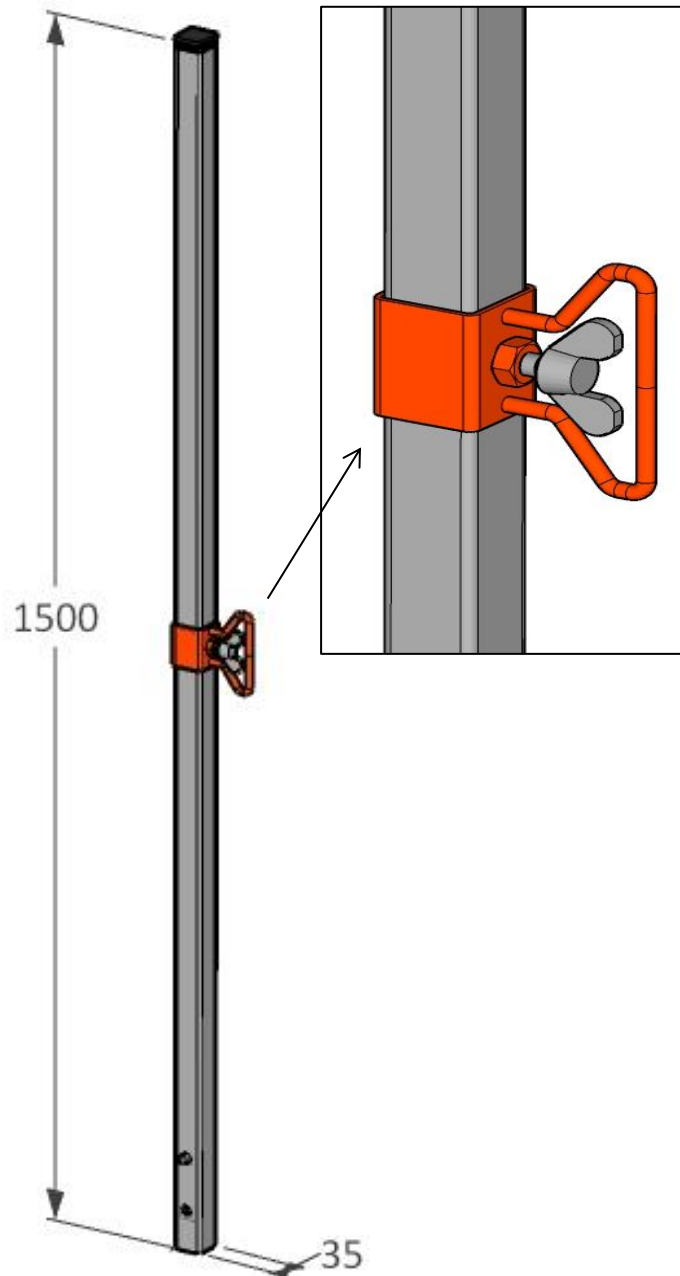
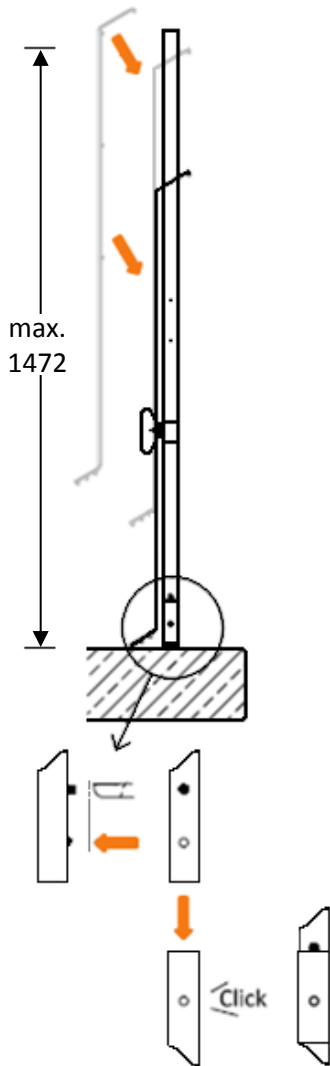

 250 pcs / EPAL

 1500 x 800 x 800 mm

 800 kg