





-  350 x 40 x 40 mm (5030240)
535 x 40 x 40 mm (5030425)
-  0,82 kg (5030240)
1,13 kg (5030425)
-  Steel / HDG
-  EN 13374-A







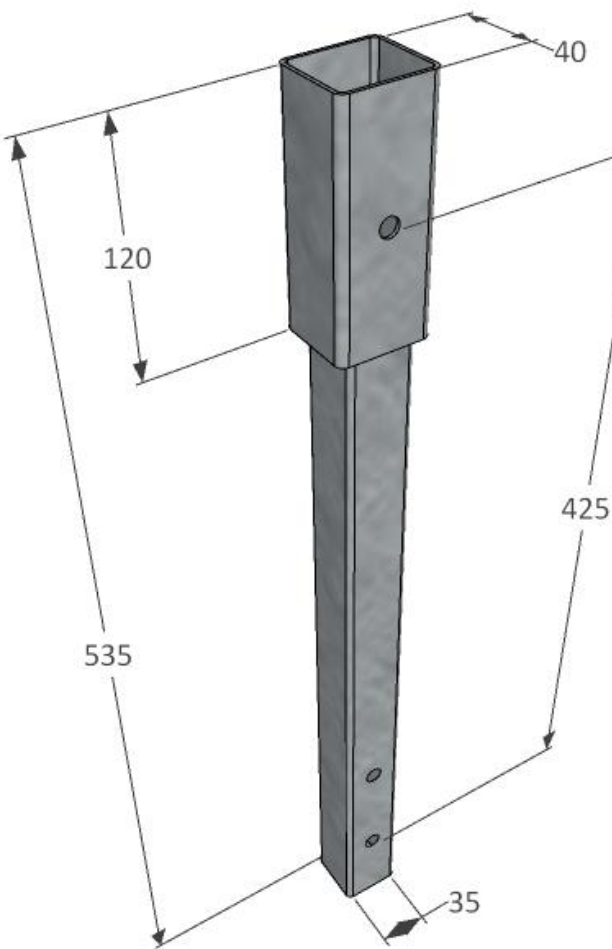
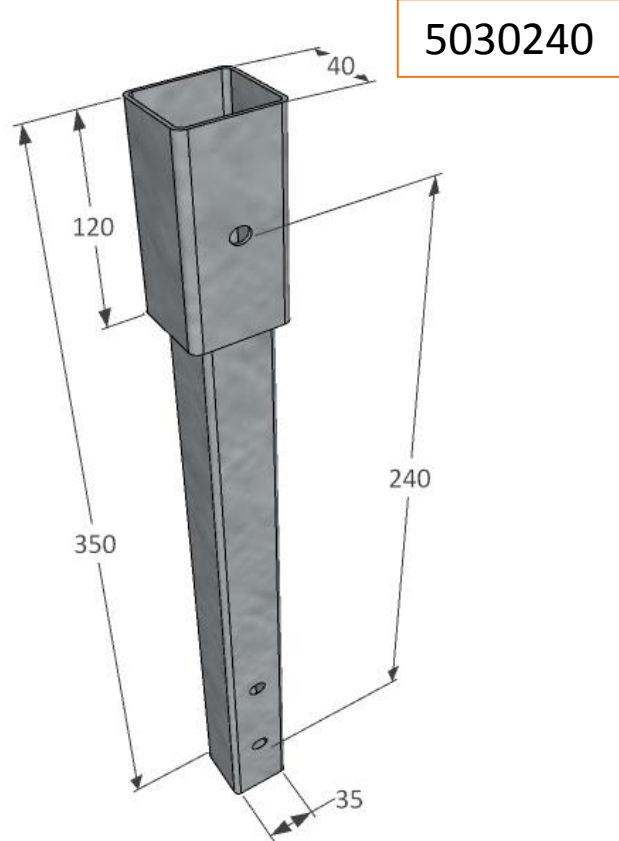

5030425



5030240



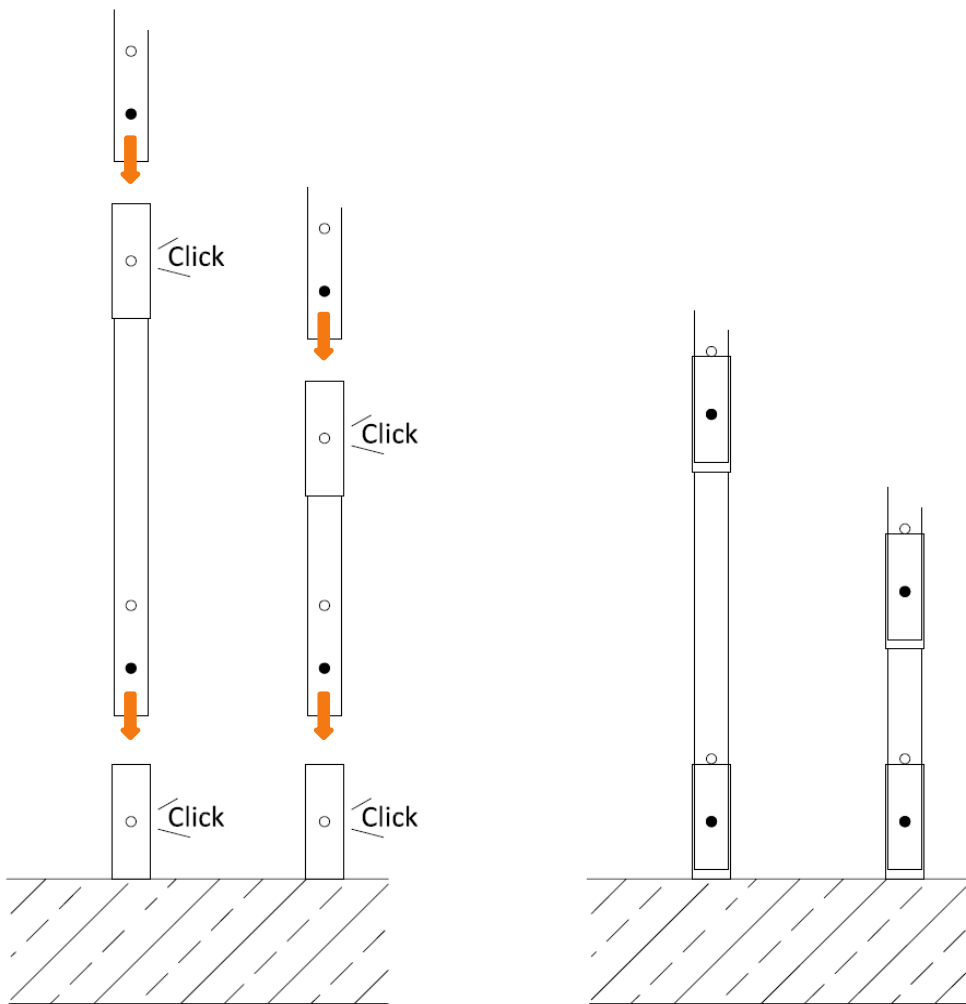

-  250 pcs / EPAL
-  1200 x 800 x 450 mm
-  225kg (5030240)
303 kg (5030425)

-  350 x 40 x 40 mm (5030240)
535 x 40 x 40 mm (5030425)
-  0,82 kg (5030240)
1,13 kg (5030425)
-  Steel / HDG
-  EN 13374-A



2/2



-  250 pcs / EPAL
-  1200 x 800 x 450 mm
-  225kg (5030240)
303 kg (5030425)