 2450 x 1120 x 100 mm

 71 kg

 Steel / HDG

 EN 12811

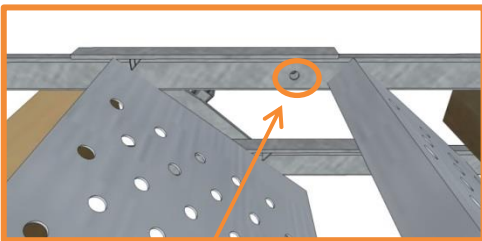

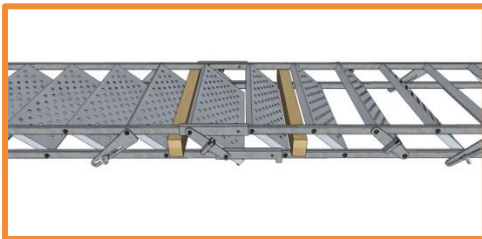
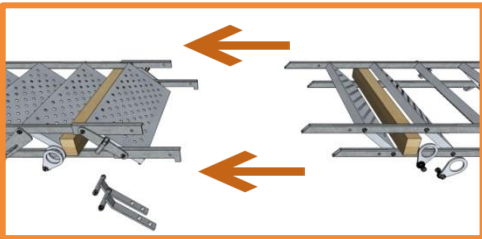
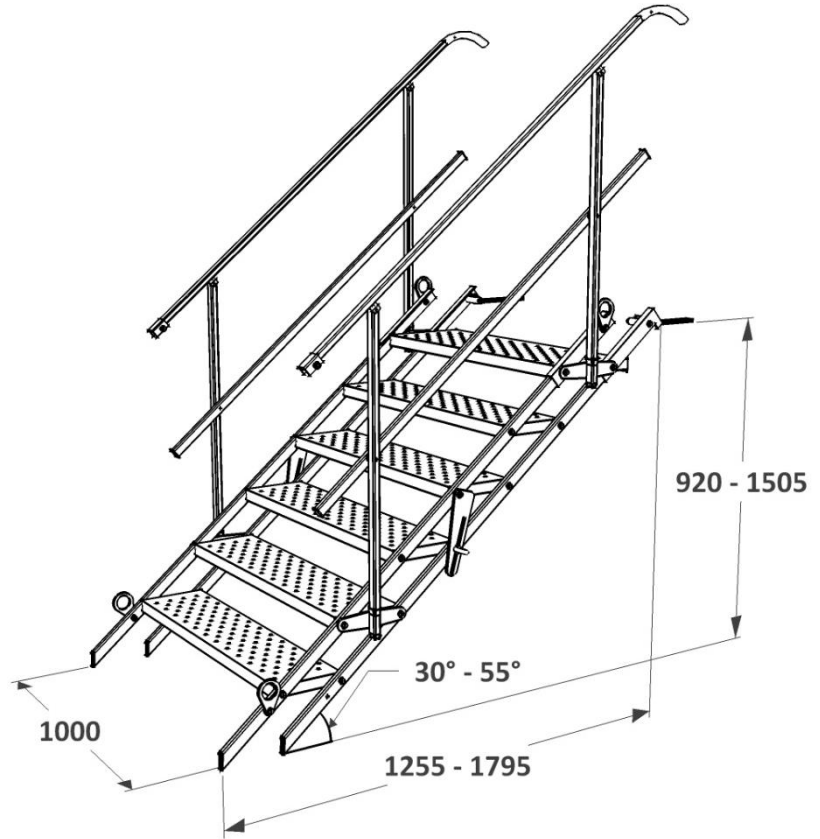

4x

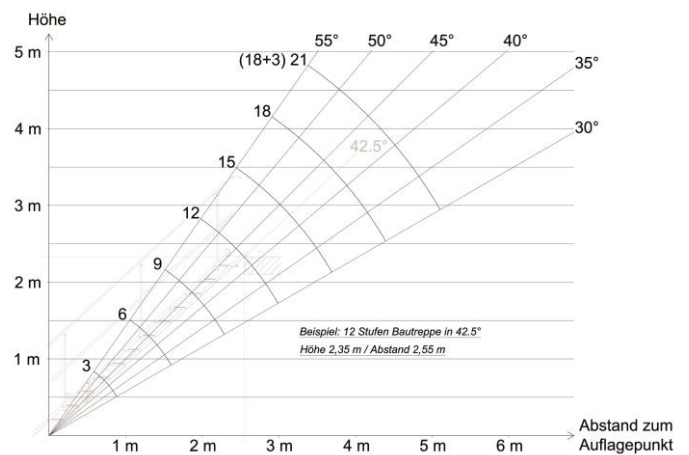
Inclination Diagram



 10 pcs / EPAL

 2450 x 1120 x 1150 mm

 730 kg

Tools:

