 2450 x 800 x 100 mm

 62 kg

 Steel / HDG

 EN 12811

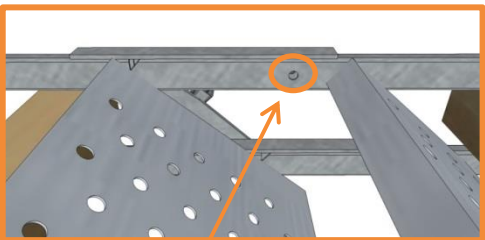
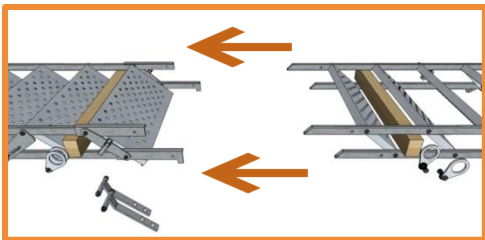
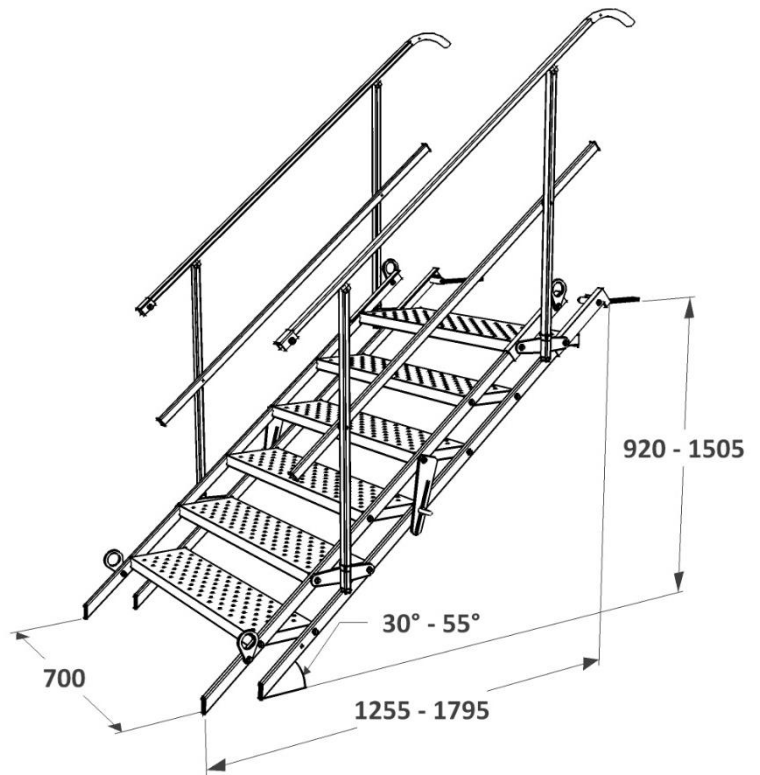

4x

Inclination Diagram

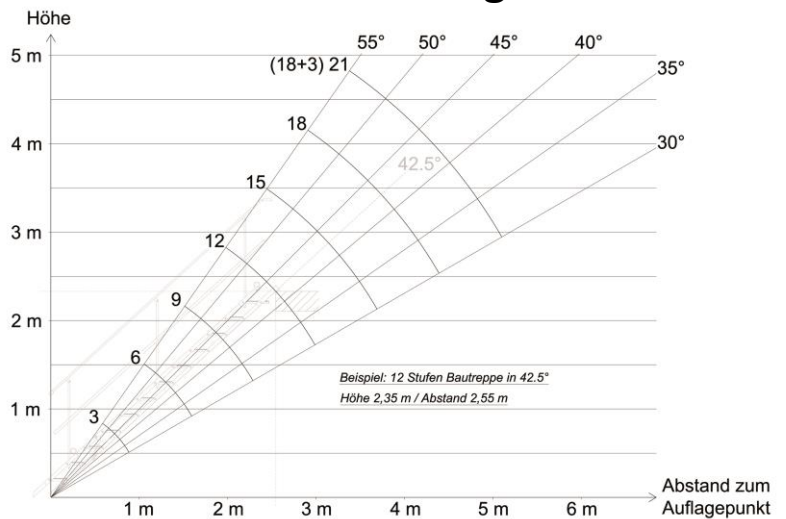

 10 pcs / EPAL

 2450 x 800 x 1150 mm

 640 kg

Tools:

