



 1500 x 35 x 35 mm

 2,9 kg

 Steel /HDG

 EN 13374-A

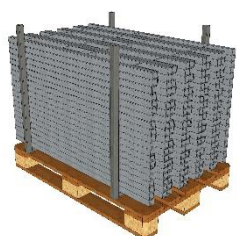
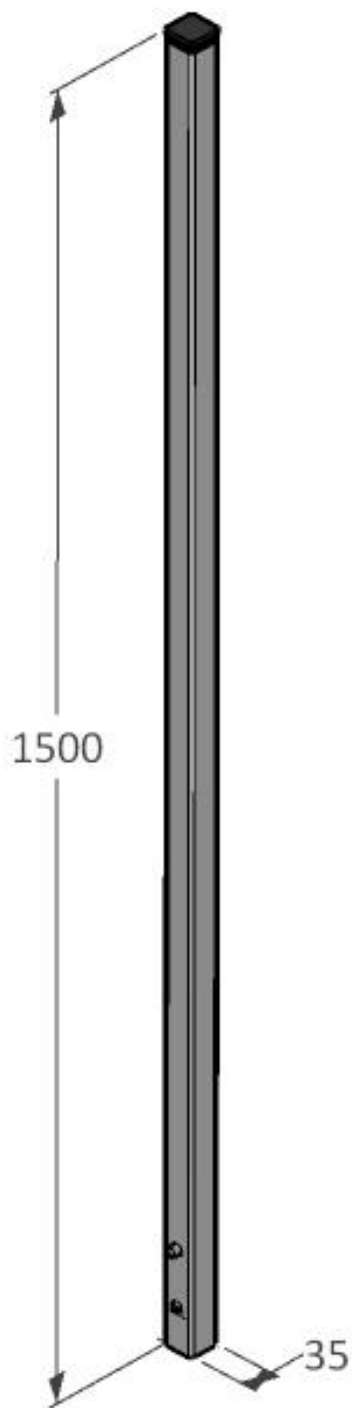
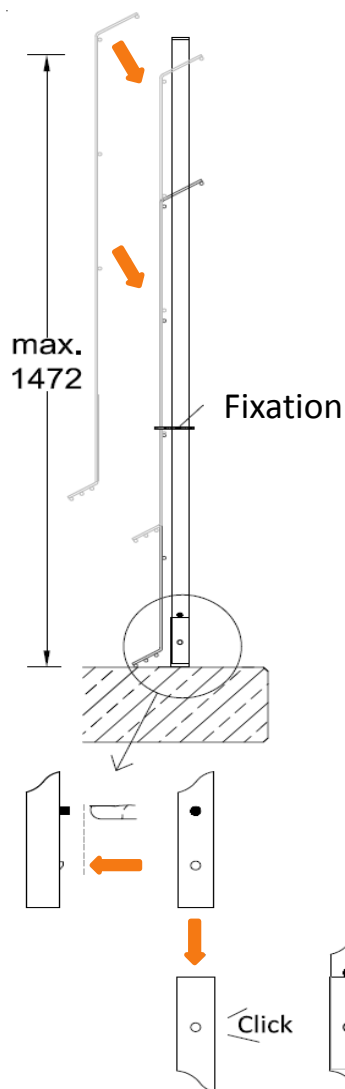

 252 pcs / EPAL

 1500 x 800 x 800 mm

 750 kg