

 200 x 100 x 20

 144 kg

 hot-dip galvanized steel

 EN 12811

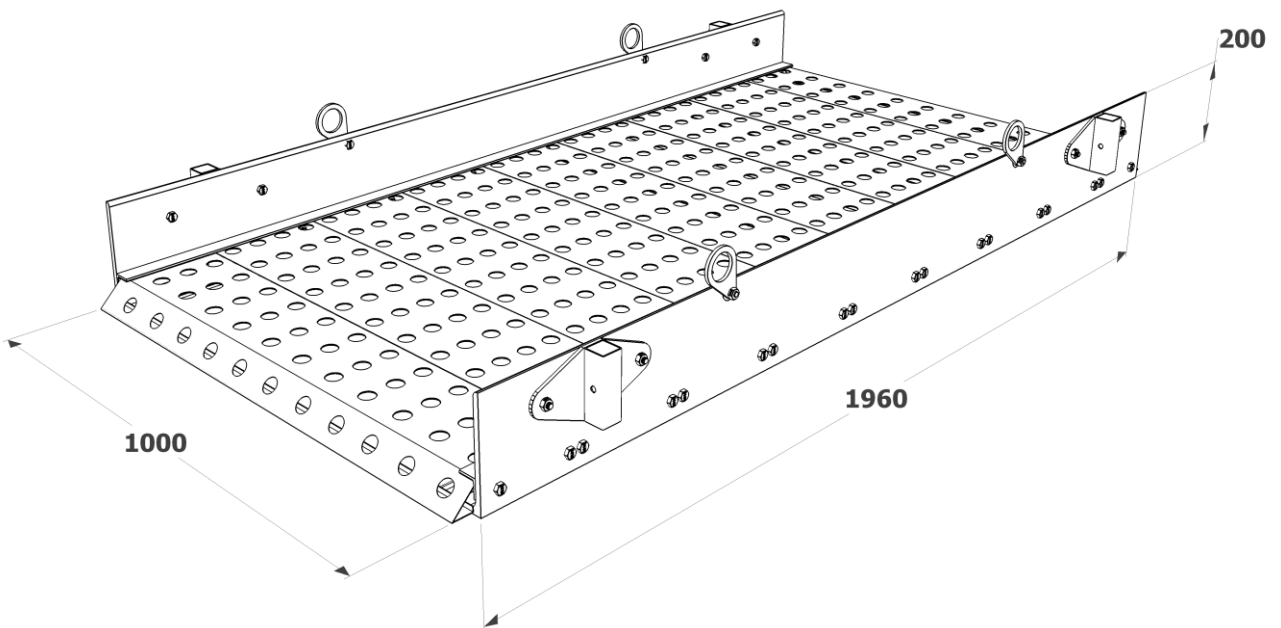
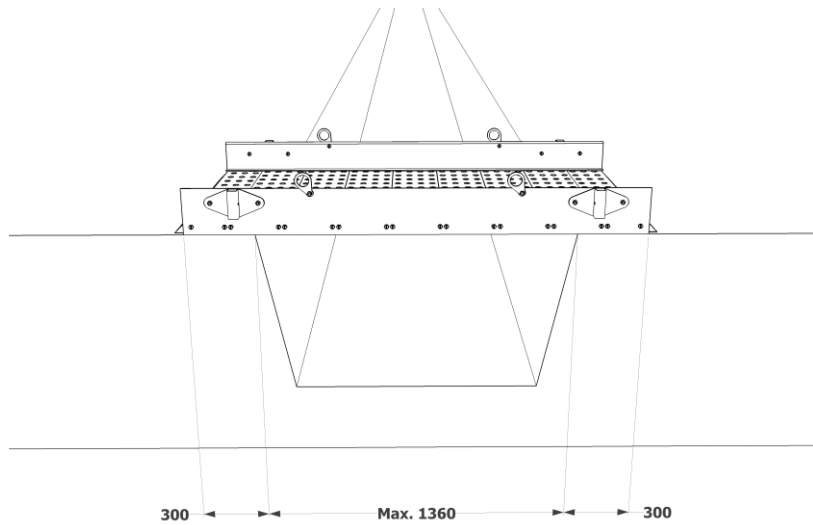
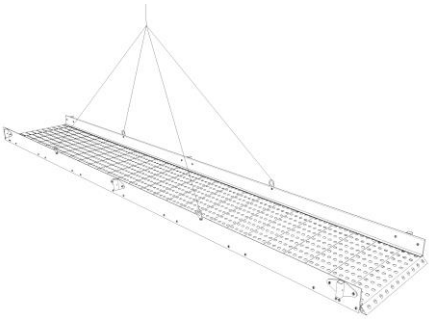

Tools: